

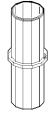



NR.137

 3.5x16 S02 x32	 S21 x4	 C01 x8	 C10 x12	 C11 x12	 P01 x4
 B01 x4					



3.

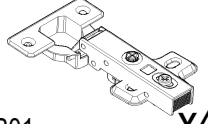
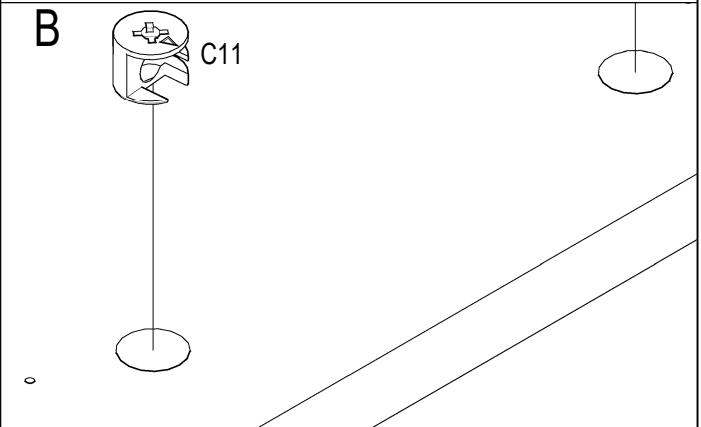
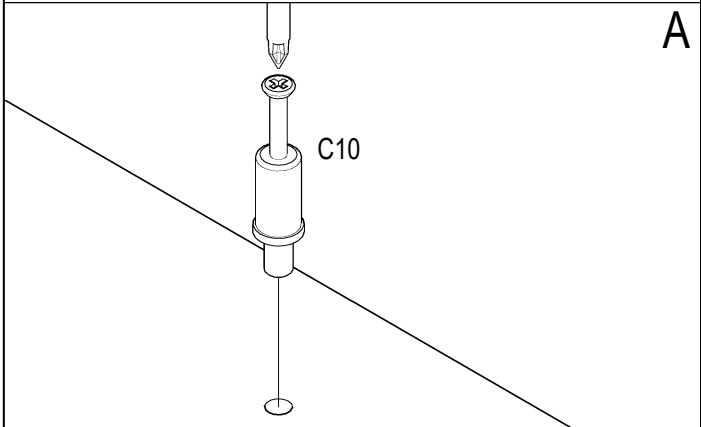
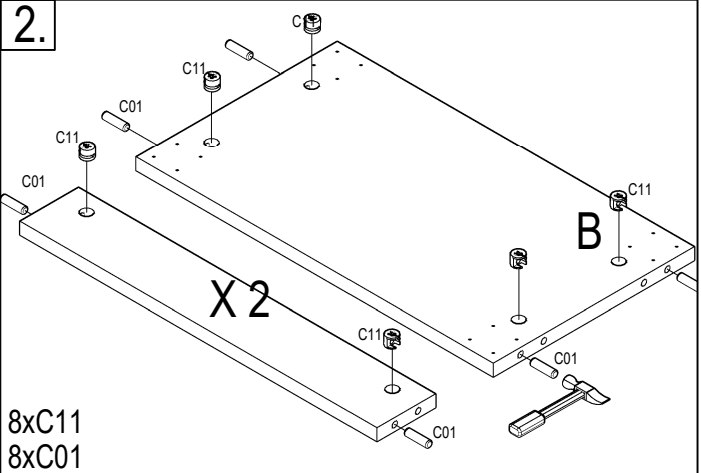
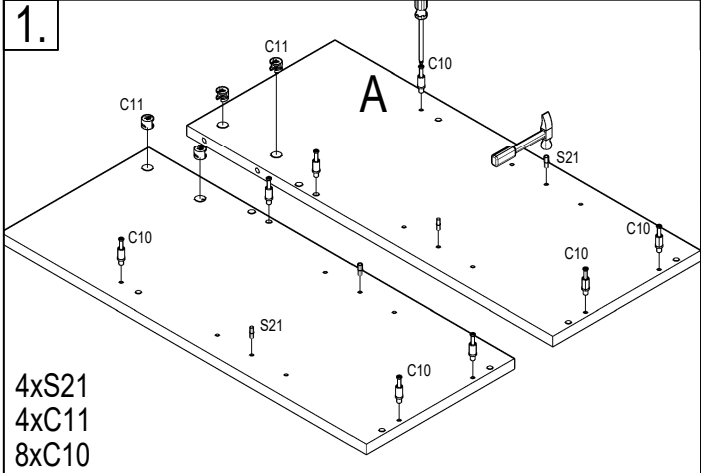
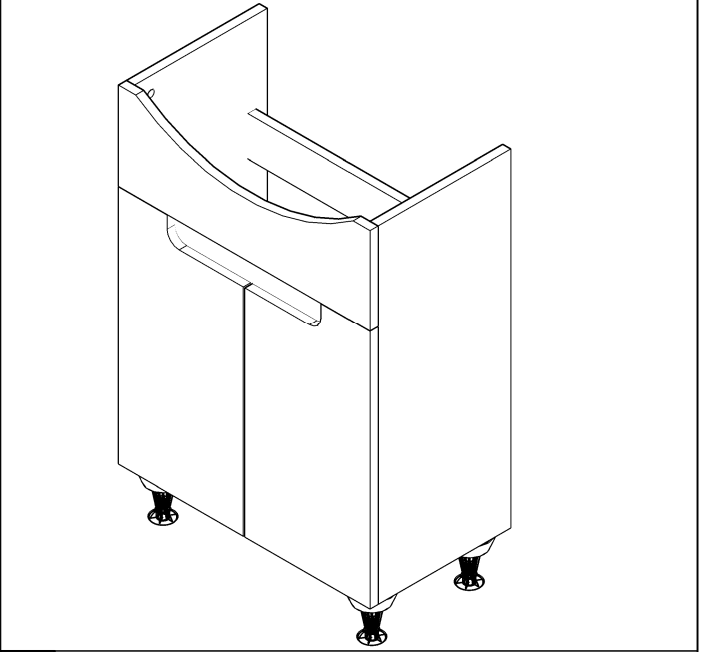
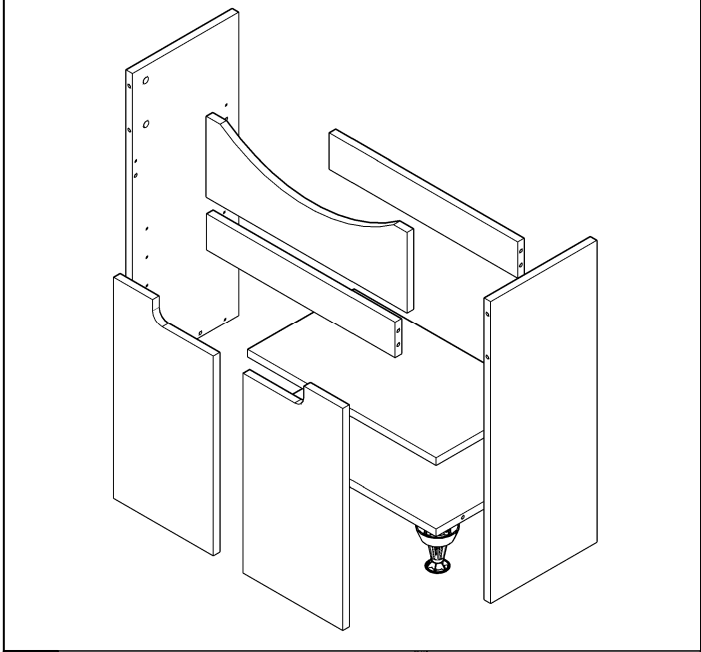
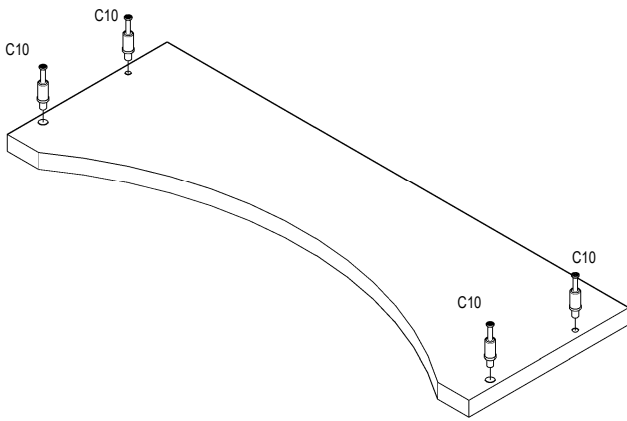

4xC10

4.

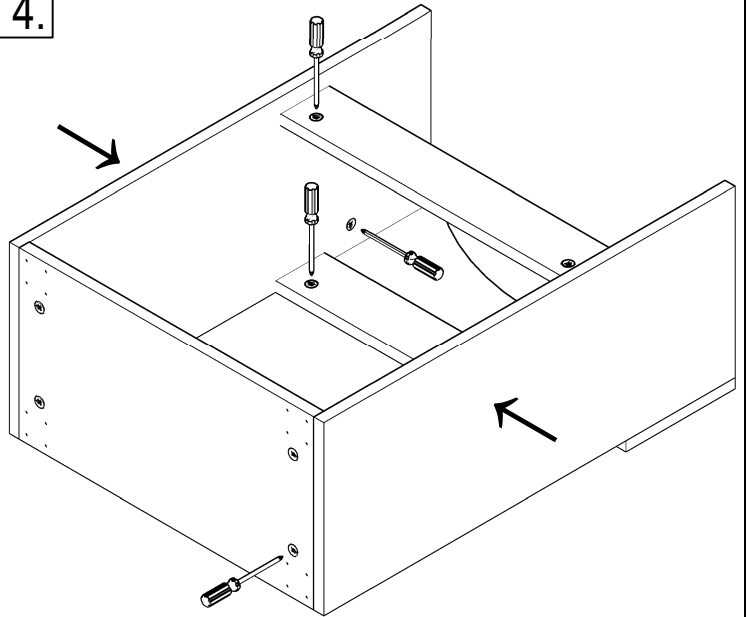

5.

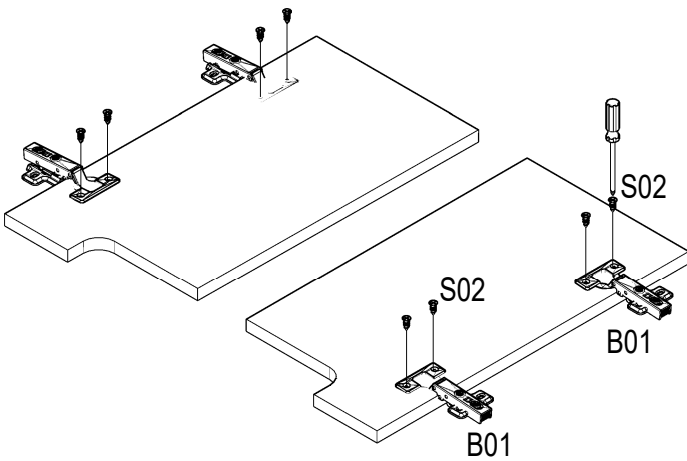

4xB01
8xS02

6.

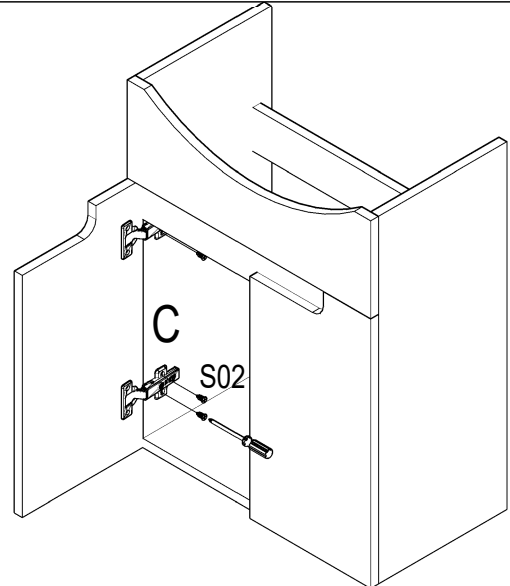

8xS02

7.

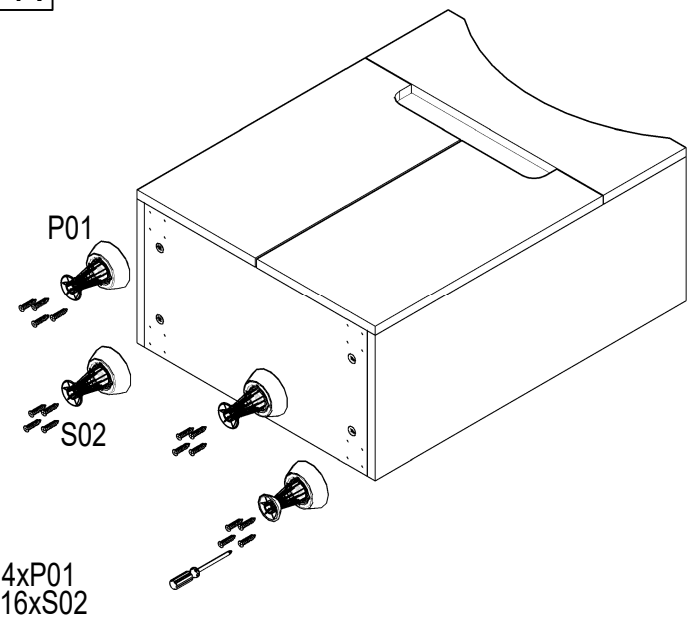

4xP01
16xS02

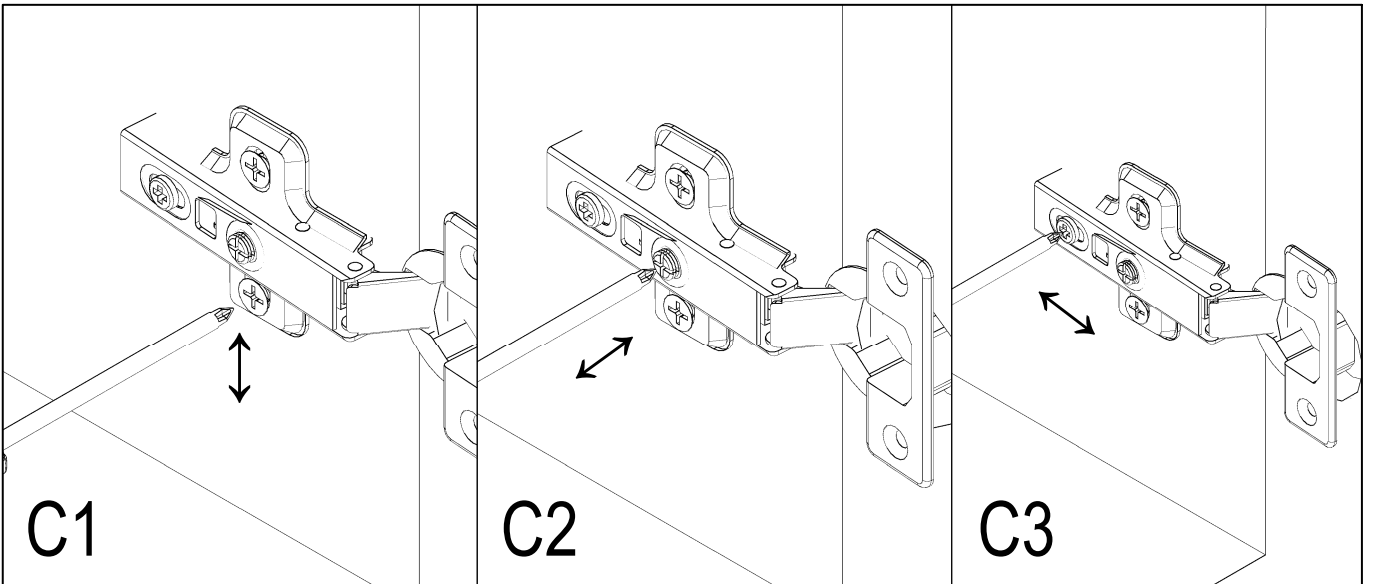

C1

C2

C3

HEIGHT ADJUSTEMENT SIDE ADJUSTEMENT DEPTH ADJUSTEMENT